

Product Overview

Aluminum Conveyors
Flexible Table Top Chain Conveyors
Pallet-Handling Conveyor Systems
Aluminum Framing

mk North America, Inc.

better products. better solutions.

mk North America, Inc.

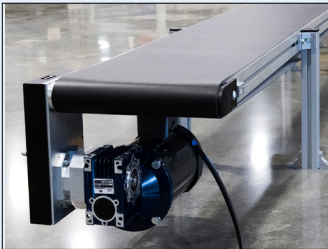

Aluminum Conveyors



Flexible Chain Conveyors



Pallet-Handling Conveyor Systems

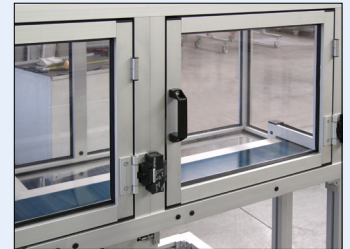

Aluminum Framing

mk North America, Inc.® is a member of the mk Technology Group and a leading worldwide manufacturer of aluminum and stainless steel conveyors, pallet-handling conveyor systems, and extruded aluminum framing.

Unsurpassed variety, maximum flexibility, superb quality and easy integration are reasons mk has become the supplier of choice for machine builders, system integrators and manufacturing companies around the globe.

Since 1988 mk has been serving the material handling industry with diverse industrial know-how, superb quality, constant innovation and application engineering excellence. mk North America, Inc. offers you a perfect solution for any application.

better products. better solutions.

«At mk North America, we pride ourselves on understanding each of our customers' unique challenges. We want to be the customer's partner in developing material-handling solutions optimized for their individual needs.» Andreas Haussmann, President 



Conveyor Systems

Cutting-Edge Conveyor Solutions

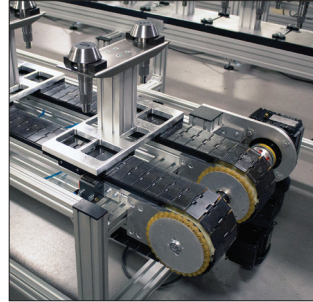
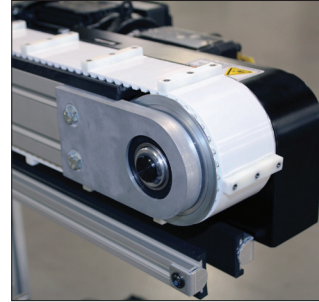
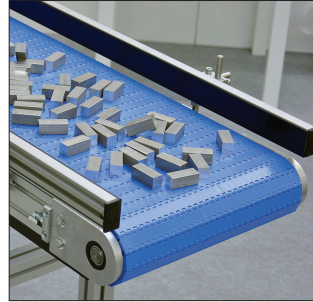
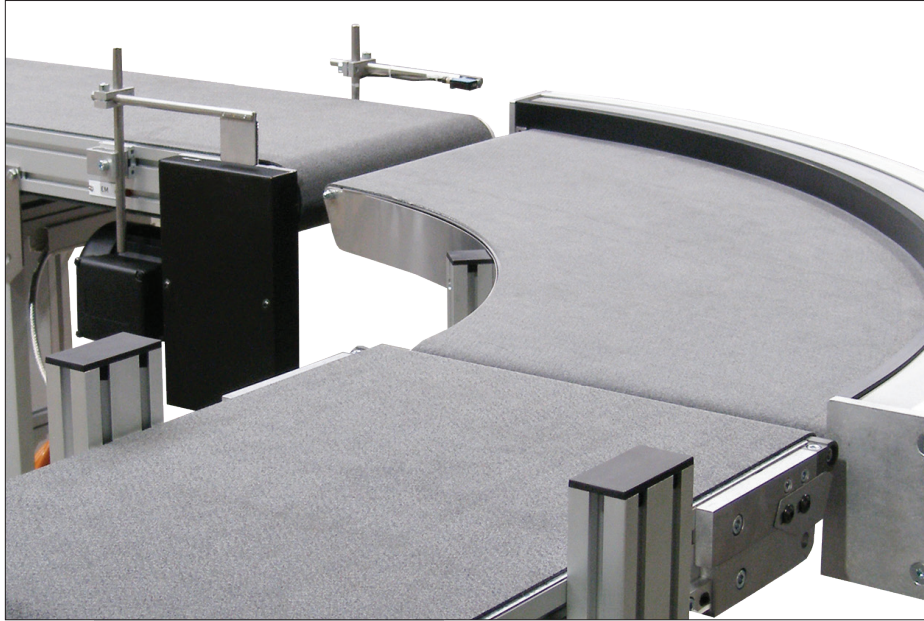

With over 20 different conveying systems, mk offers a product variety which is unsurpassed in the marketplace. Our broad offering of aluminum frame and stainless steel conveyors, and more than 30 years of experience in material handling, leads to robust conveyor solutions that feature a long life and reliable operation while maintaining all the advantages of modular design and expandability.

Our innovative conveying solutions, both standard and custom, have proven themselves in: automotive, battery production, consumer goods, electronics, food products, manufacturing, machine builder & integrators, metal working, packaging, pharmaceutical and printing industries.

Product Offering

Flat Belt	Flat Top Chain
Cleated Belt	Roller Chain
Plastic Modular Belt	Accumulating Roller
Cleated Modular Belt	Chain
Timing Belt	Gravity Roller
Wide Timing Belt	Driven Roller
Attachment Timing Belt	Motorized Roller

Configurations

- Horizontal
- Curve
- Incline
- Z-Frame
- Multi-lane
- Wedge

Engineered Solutions

From modified standard conveyors to complete custom designs, our innovative solutions increase your line's performance and achieve better results. We offer special engineered solutions for:

Buffering & Storage	Vision & Inspection
Parts Orientation & Positioning	Line Access
Diverting, Merging & Sorting	Specialty Belting
Indexing	Extreme Duty Applications

Flexible Chain Conveyors

Flexibility Through Versatility

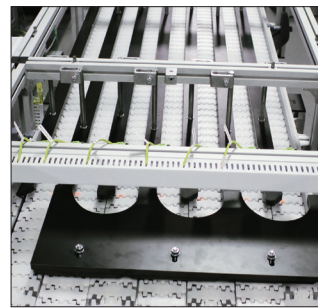
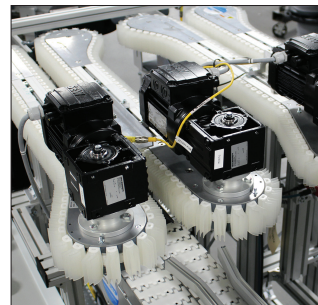
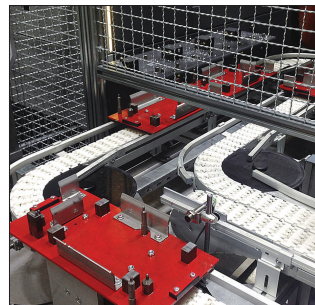
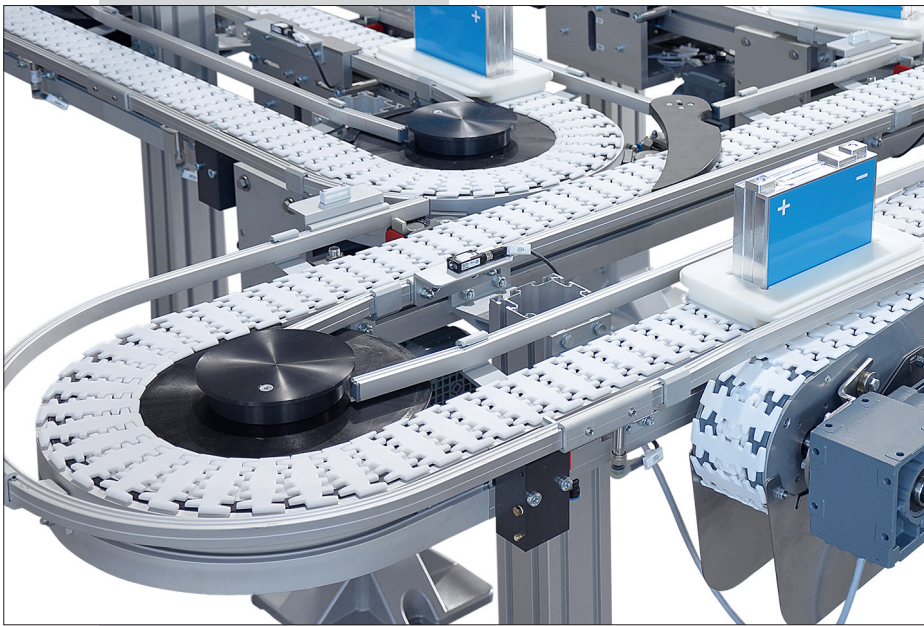

versaflex

VersaFlex flexible flat top chain conveyors are ideal for conveying product in three-dimensional space. They feature plain or customized chains; providing nearly limitless possibilities. VersaFlex features a modular design. The standardized modules and components make it simple and cost effective to integrate the system into any production process, as well as to adapt and expand the line and production needs change.

VersaFlex is a conveyor system that grows with your requirements. Moreover, it is compatible with other systems that are currently available on the market, as well as mk's other conveyor lines.

Conveyor Configurations

Horizontal	Recirculating
Incline	Vertical
Wedge	Small Pallet
Alpine	Puck Handling

Chain Widths

63 mm
83 mm
103 mm
175 mm
295 mm

Solutions

- Accumulation
- Vertical Storage
- Singulate Product and Pallets
- Multi-level Conveyor Lines
- Side-gripping Wedge Conveyors
- Merge Conveyor Lines
- Small Product End Transfers

VersaFlex flexible flat top chain conveyors are also ideal for small pallet and puck handling. When using a pallet or a puck unstable or irregular shaped parts and product can be conveyed with ease.

- Merge Units - for merging multiple conveyor lines together
- Pallet & Puck Stops
- Lift and Locate Units

Pallet-Handling Conveyor Systems

Conveyor Systems for Automation

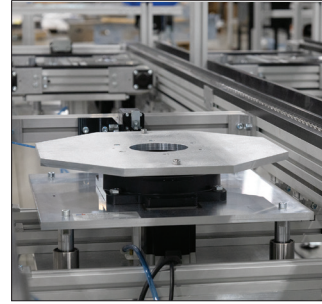
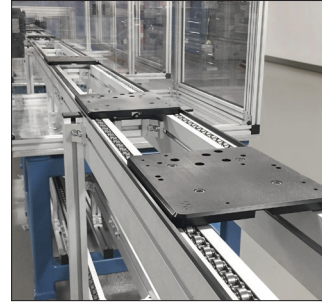
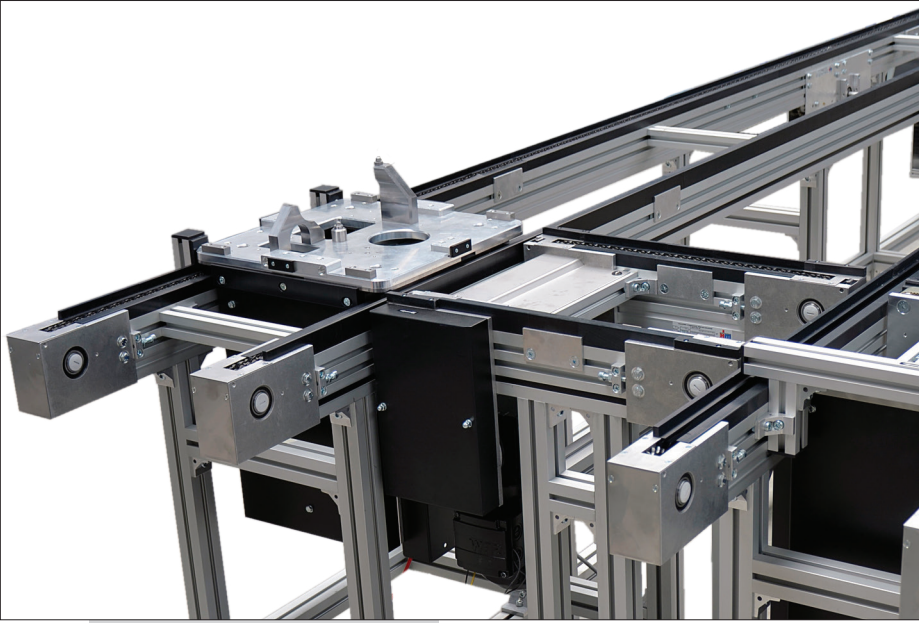

versamove
pallet-handling systems

VersaMove is a workpiece pallet based conveyor system designed to improve manufacturing productivity and product quality while allowing for maximum process flexibility.

Each platform offers a complete series of pallet-based transfers, positioning and control modules to satisfy most requirements.

- ✓ Pallet sizes up to 1,200 x 1,200 mm
- ✓ Loads up to 800 lbs./pallet
- ✓ Repeat accuracy +/- 0.1 mm
- ✓ Accumulation, storage, staging, indexing and cycling operations

System Modules

Conveyors
Transfer Conveyors
Workpiece Pallets
Lift & Transfer Units
Lift & Locate Units
Lift & Rotate Units

Vertical Transfer Units
Undamped Pallet Stop
Damped Pallet Stop
Angle Pallet Stop
Return Stop
Lift Gate Conveyors

Offering

Accumulating Roller Chain
Side-Flexing Chain
Timing Belt

System Solutions

- Accumulation & Storage
- Manual, Electric & Pneumatic Pallet Accessories
- Electric & Pneumatic Pallet Stops
- Multi-level Conveyor Lines
- Optional Safety Guarding
- Extreme Duty Applications

mk offers workpiece pallet-handling conveyor systems as unique as each product being conveyed. Countless configurations are possible with VersaMove; and with the ability to mix and match conveyor platforms, the possibilities are endless. With VersaMove you can easily change elevations, allow for line access and more.

Aluminum Framing

Flexibility Through Modularity

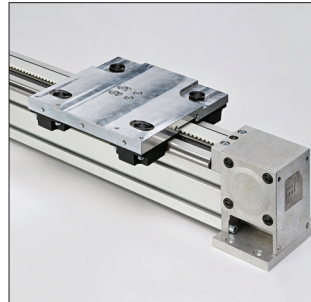
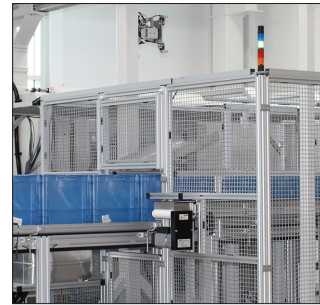
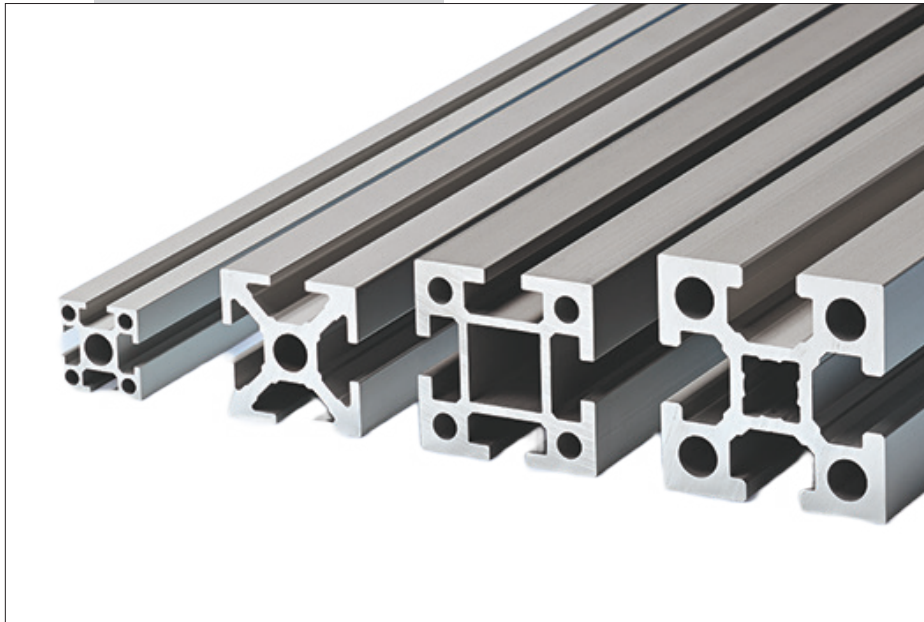

With mk Aluminum Framing you can build just about anything you can imagine. Whether it be machine bases, safety enclosures, perimeter guards, tool racks, robot stands, carts, workstations, linear modules, display units or custom construction, mk has a solution.

- ✓ Raw stock and bulk order discount
- ✓ Cut to length and kits also available

Extruded Aluminum Framing

Over 200 Different Profile Shapes
Countless Connection Methods
Bulk, Kit, Turn-key Assembly

Guarding

Machine & Perimeter Guarding
Safety Enclosures
Wide Variety of Paneling Options

Factory Equipment

Standard & Custom Workstations
Kanban & Storage Racks
Material Shuttles & Storage Carts

Linear Motion

Timing Belt Driven Actuators
Linear Positioning Modules

CAD360!



CAD360!

mk's CAD360! allows you to effortlessly model and download not only the simplest of conveyors, but also entire conveyor systems as featured in our VersaMove line. Simply input the desired values for length, width and height. Select drive location and which options you would like and the model is generated right before you.

CAD360! allows you to:

- Download 3D, 2D and image files
- Develop a conveyor to meet your specific needs
- Request a quote and discuss any custom need

Engineered Solutions

In partnership with our customers, mk excels at offering not only a better product, but a better solution. Whether this means utilizing a product from our standard offering or developing an innovative, custom engineered solution for your particular application, mk has you covered.

Services & Support

- Application Support
- Approval Drawings
- Field Support
- Integration & Controls
- Start-up Assistance
- Maintenance & Spare Parts
- Made in USA
- FAT & SAT



mk North America, Inc.
a mk Technology Group Company
105 Highland Park Drive
Bloomfield, CT 06002 USA
Phone: (860) 769-5500
www.mknorthamerica.com
info@mknorthamerica.com

VersaMove and VersaFlex are registered trademarks of mk North America, Inc.
All rights reserved, information subject to change without notice. © 2022 mk North America, Inc.